

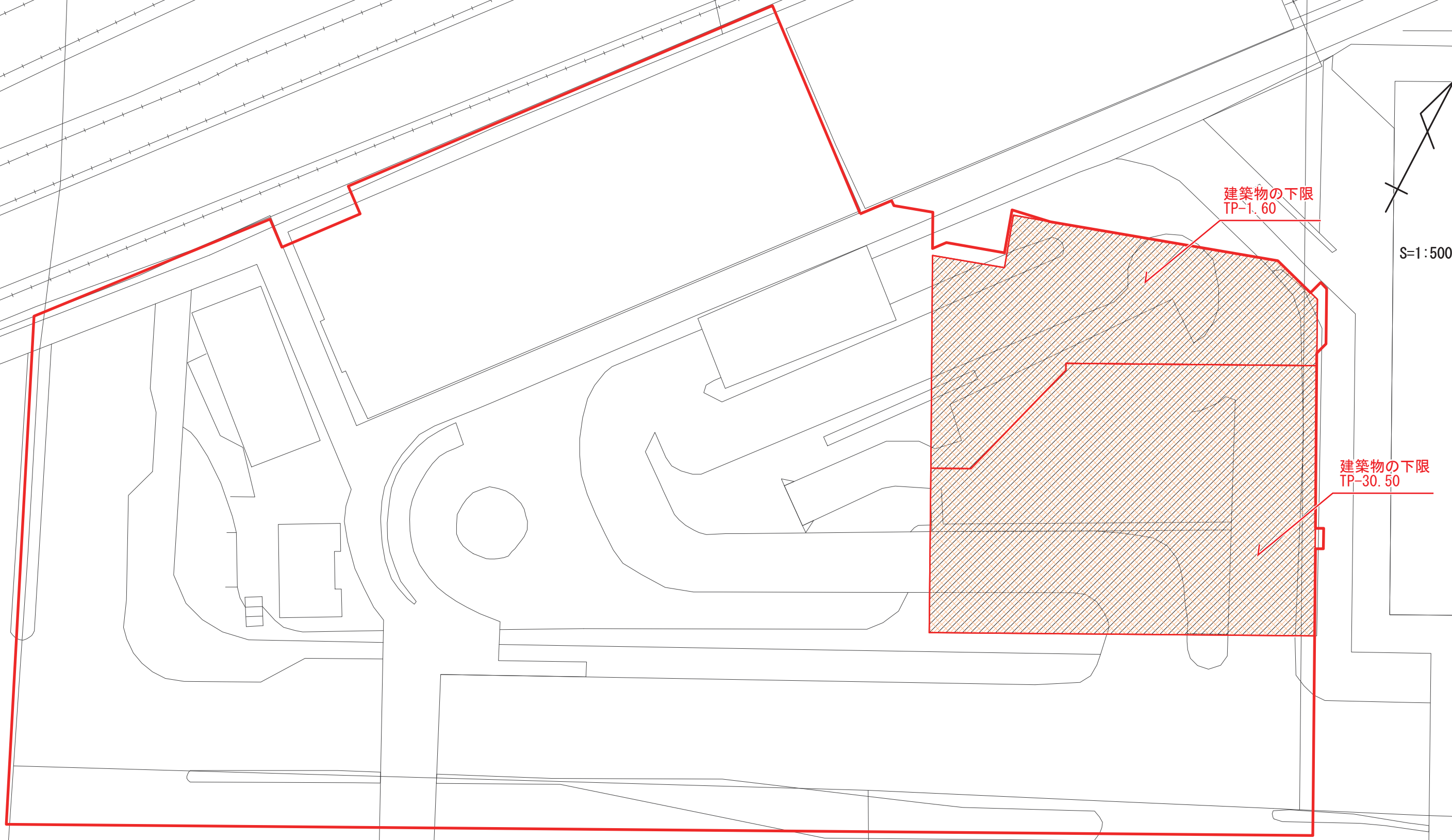



S=1:1,000

礎上線





税関線(フラワーロード)

凡 例	
	都市再生特別地区の区域
	壁面位置の制限
	建築物の高さの最高限度 (低層部: 25m)
	建築物の高さの最高限度 (中層部①: 62m)
	建築物の高さの最高限度 (中層部②: 100m)
	建築物の高さの最高限度 (高層部: 161m)
	都市施設である道路の区域のうち、建築物等の敷地と併せて利用すべき区域 (重複利用区域)

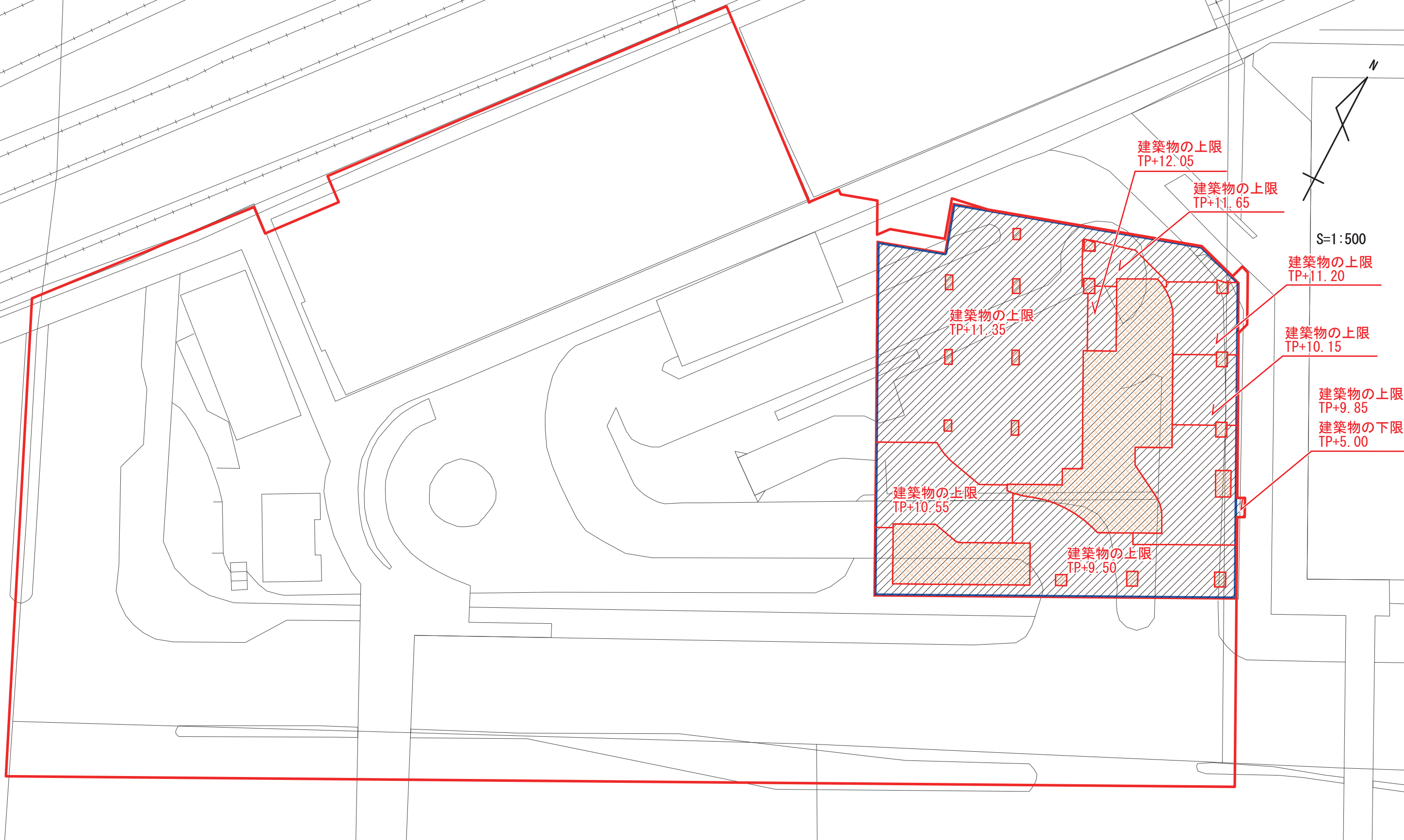

凡 例	
	重複利用区域内における建築等可能区域
	重複利用区域のうち、上階で建築物の上限を定める区域
	都市再生特別地区の区域





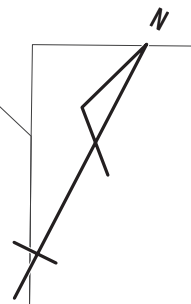

凡 例			
	重複利用区域内における建築等可能区域		重複利用区域のうち、上階で建築物の上限を定める区域
	都市再生特別地区の区域		重複利用区域のうち、下階で建築物の下限を定める区域

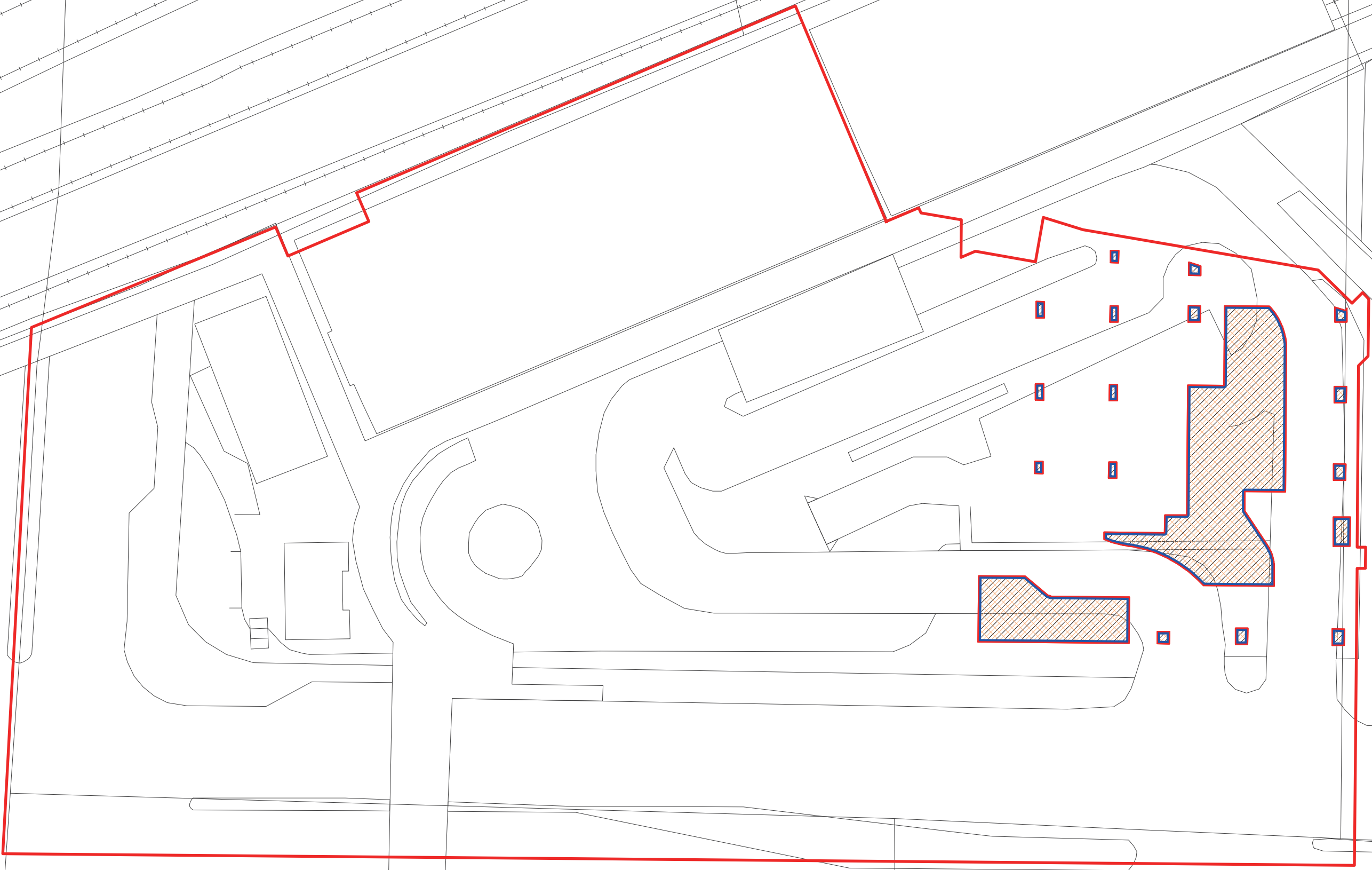





S=1:500

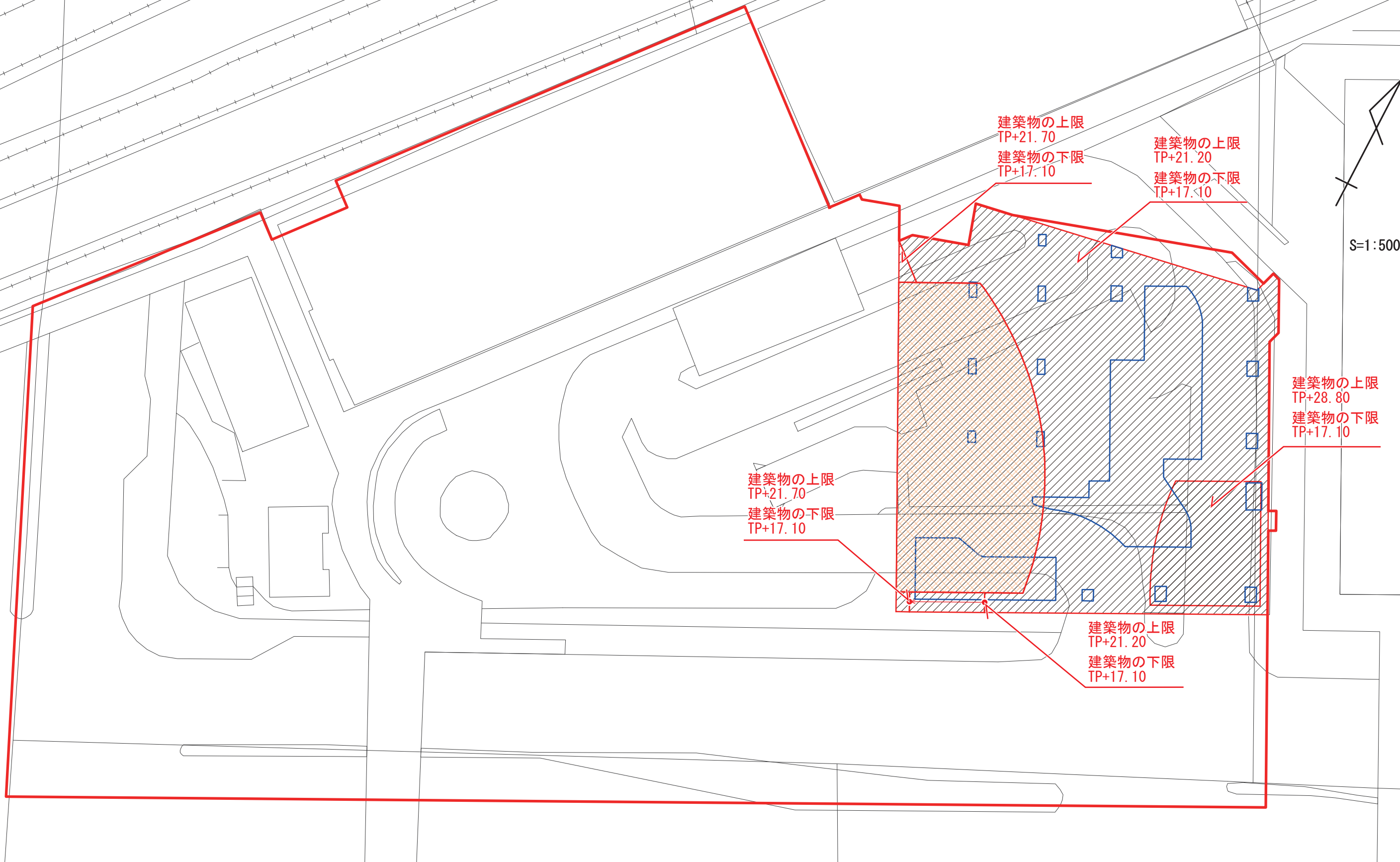

凡 例			
	重複利用区域内における建築等可能区域		重複利用区域のうち、上階で建築物の上限を定める区域
	都市再生特別地区の区域		重複利用区域のうち、下階で建築物の下限を定める区域



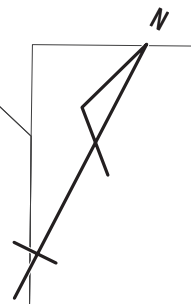

凡 例			
	重複利用区域内における建築等可能区域		重複利用区域のうち、上階で建築物の上限を定める区域
	都市再生特別地区の区域		重複利用区域のうち、下階で建築物の下限を定める区域

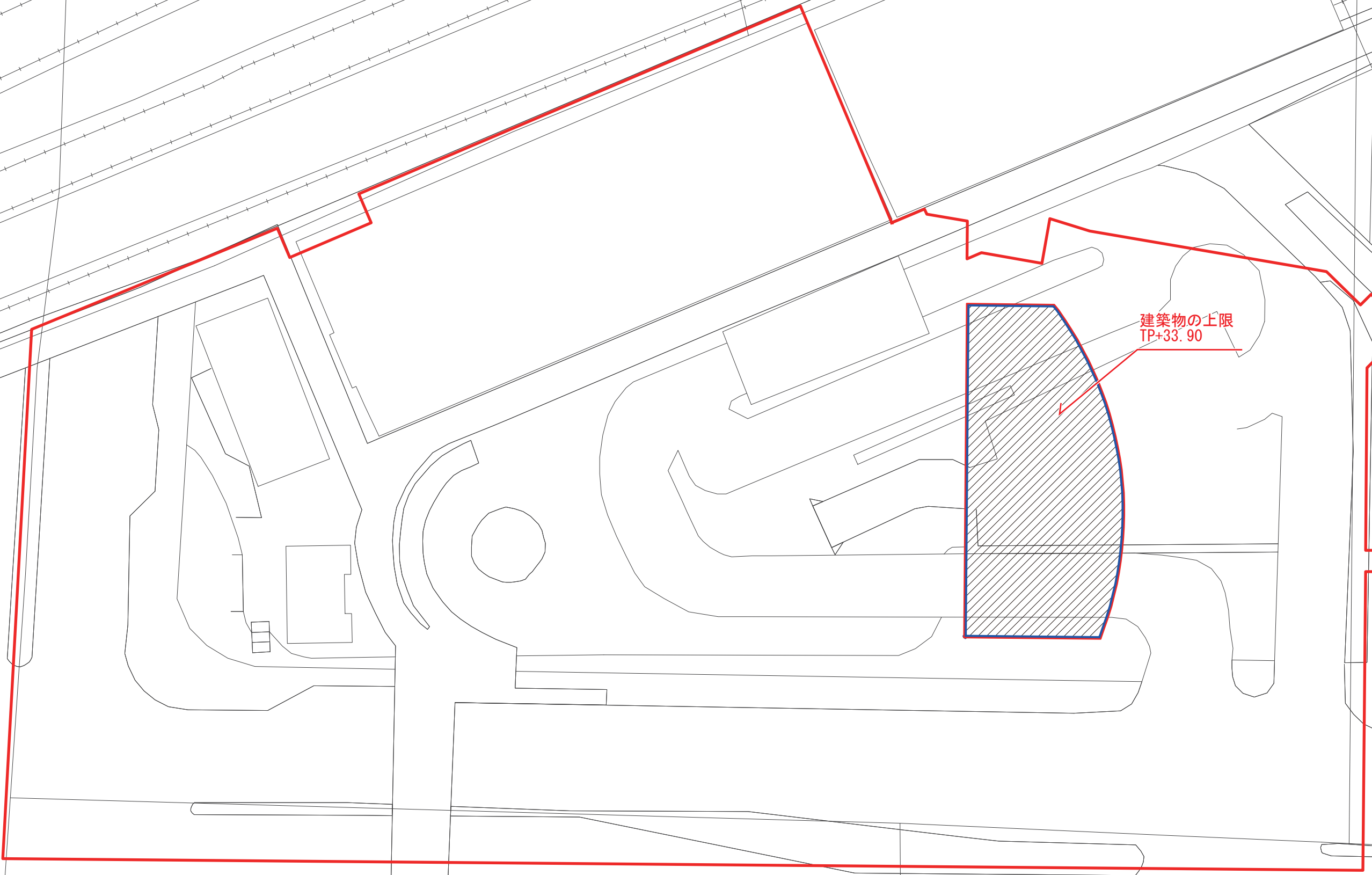

S=1:500



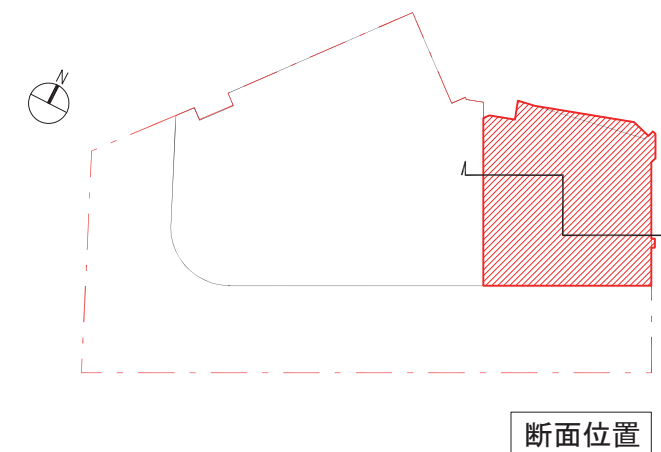
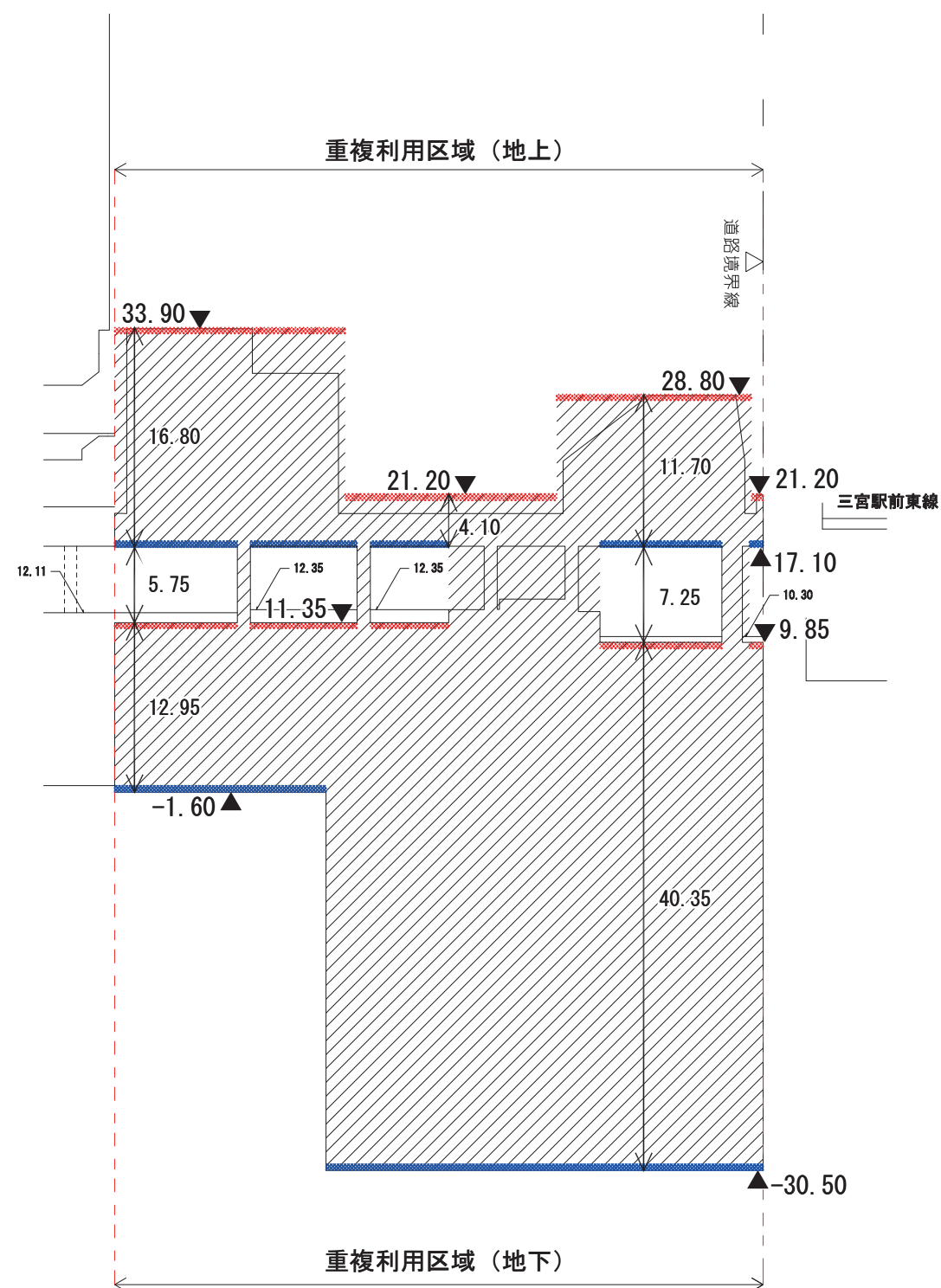

建築物の上限
TP+33.90

凡 例	
	重複利用区域内における建築等可能区域
	重複利用区域のうち、下階で建築物の下限を定める区域
	都市再生特別地区の区域



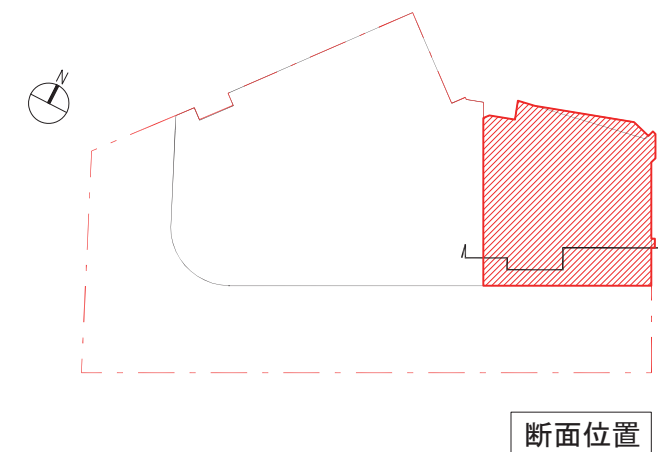
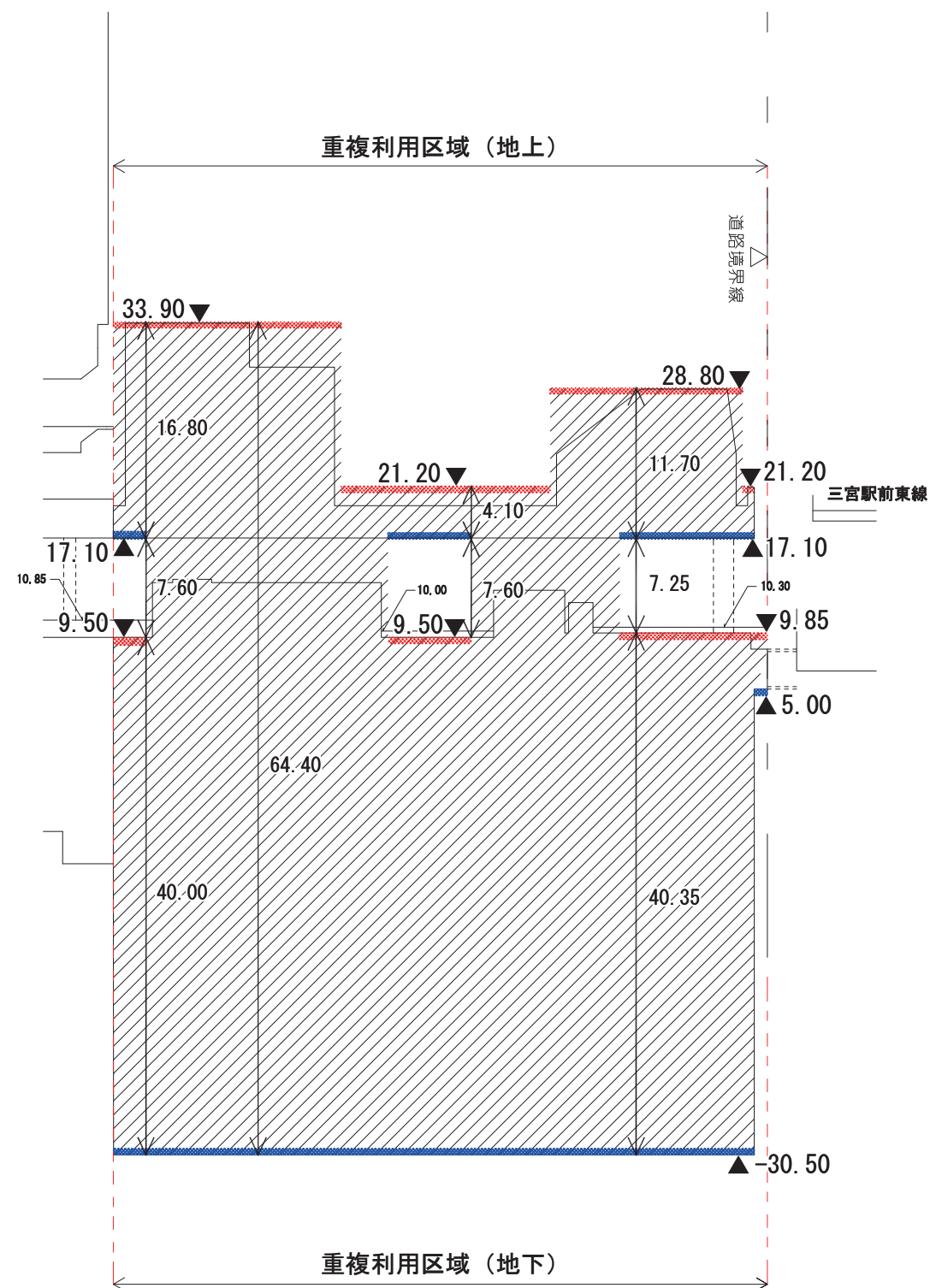

S=1:500

凡 例	
	建築物等の建築又は建設の限界（上限）
	建築物等の建築又は建設の限界（下限）
	重複利用区域内における建築等可能区域



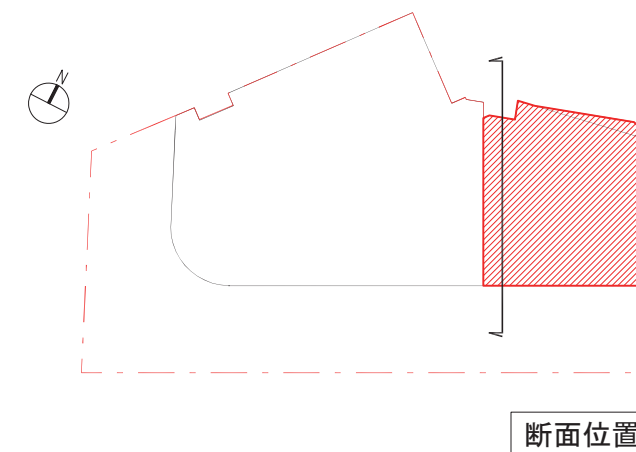
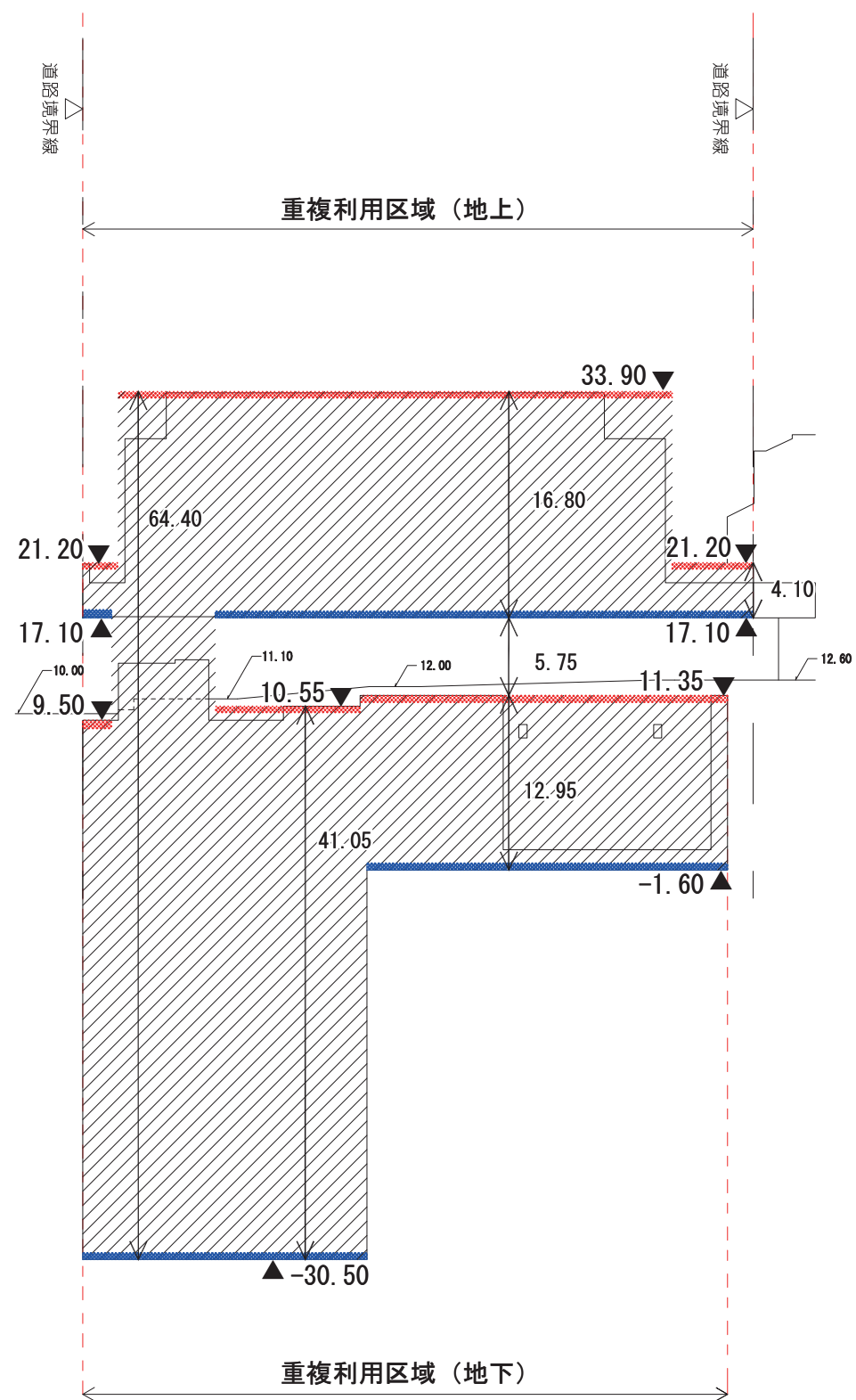

S=1:500

凡 例	
	建築物等の建築又は建設の限界（上限）
	建築物等の建築又は建設の限界（下限）
	重複利用区域内における建築等可能区域



S=1:500

凡 例	
	建築物等の建築又は建設の限界（上限）
	建築物等の建築又は建設の限界（下限）
	重複利用区域内における建築等可能区域

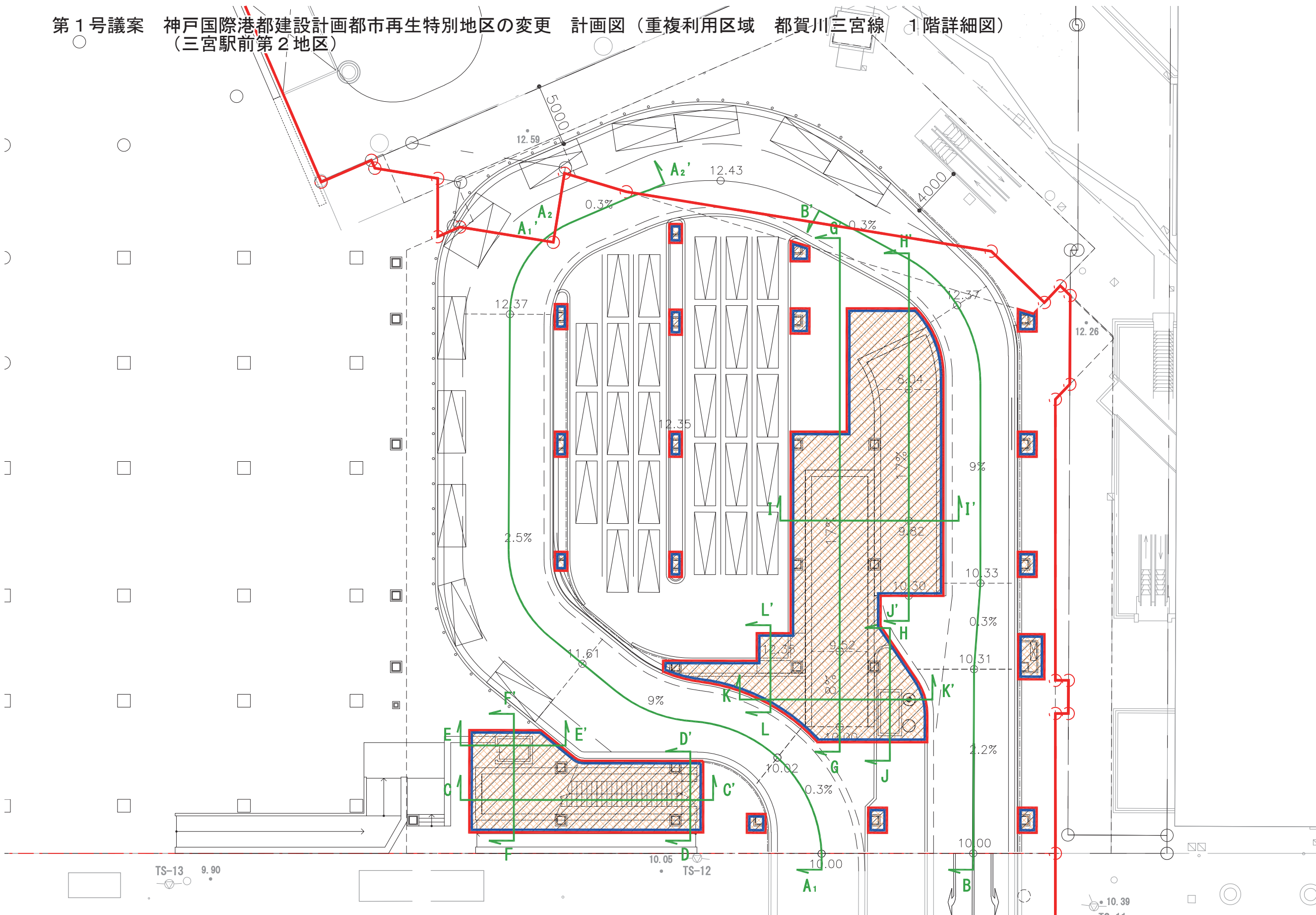

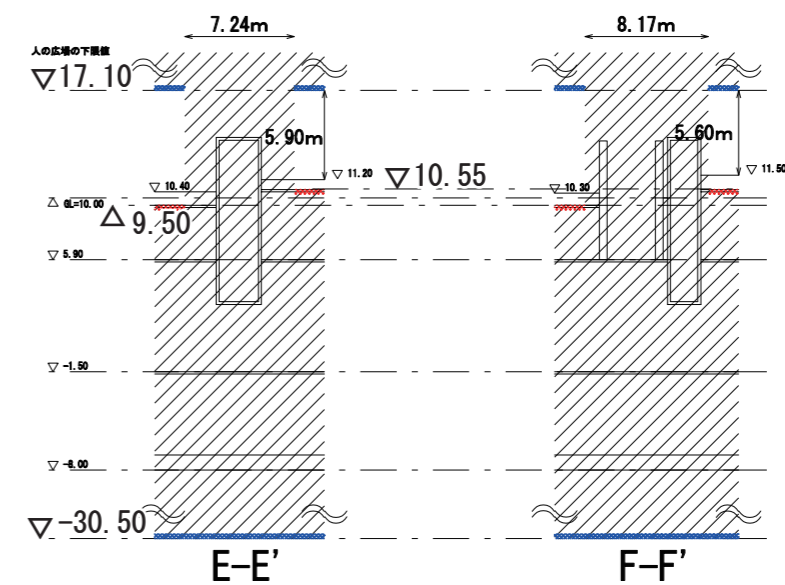
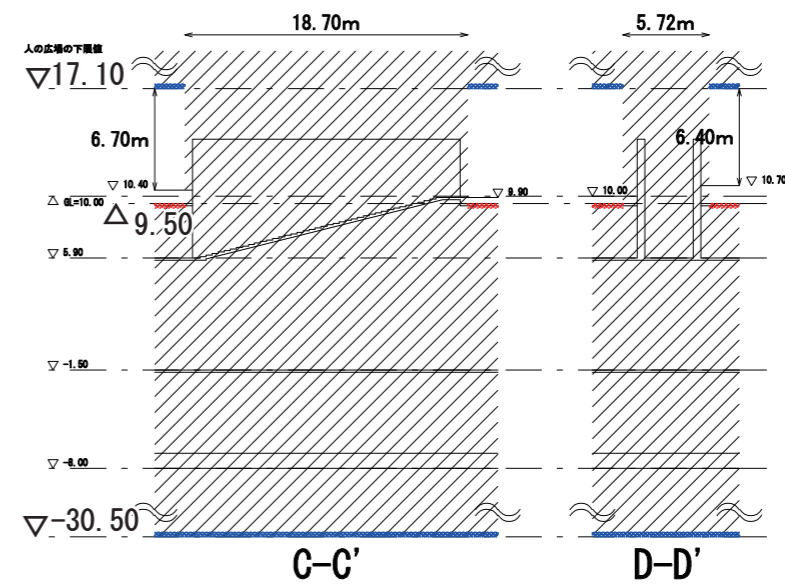
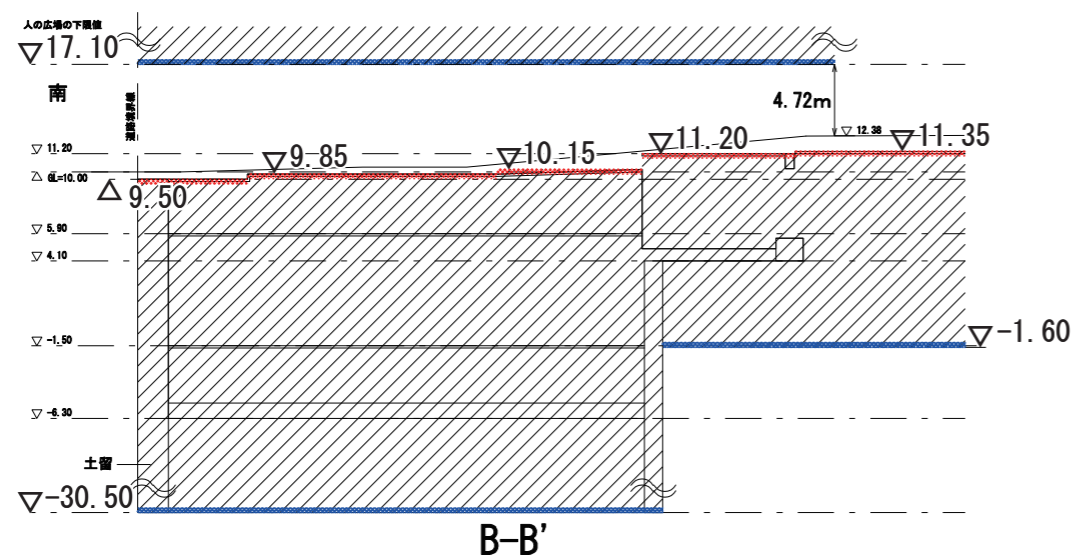
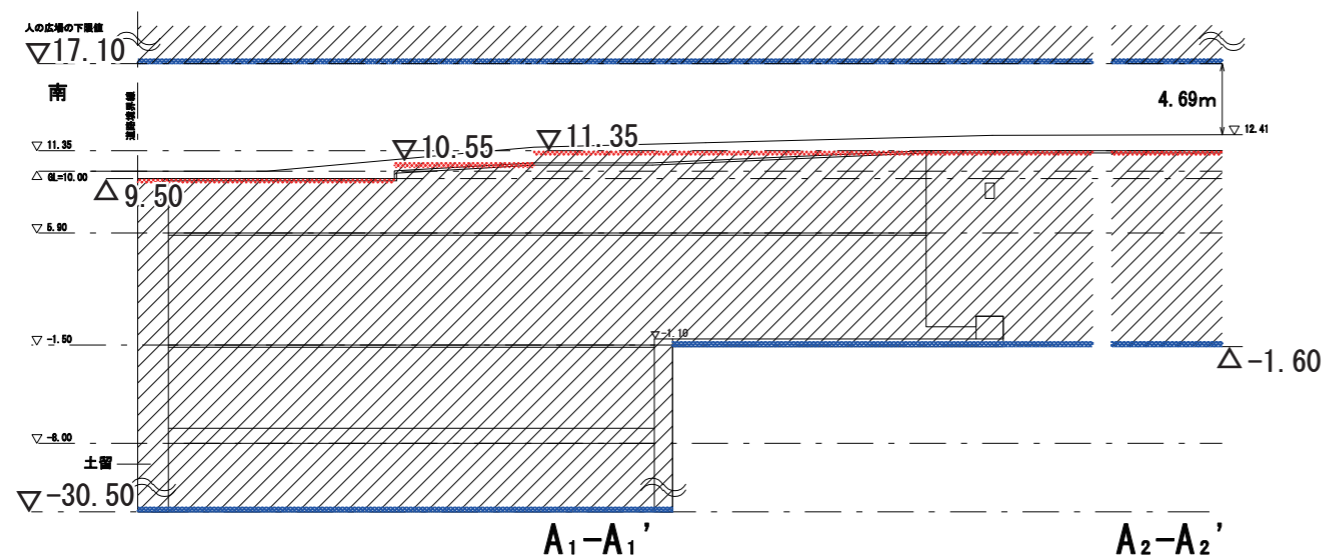

N
 S=1:300

凡 例			
	重複利用区域内における建築等可能区域		重複利用区域のうち、上階で建築物の上限を定める区域
	都市再生特別地区の区域		重複利用区域のうち、下階で建築物の下限を定める区域



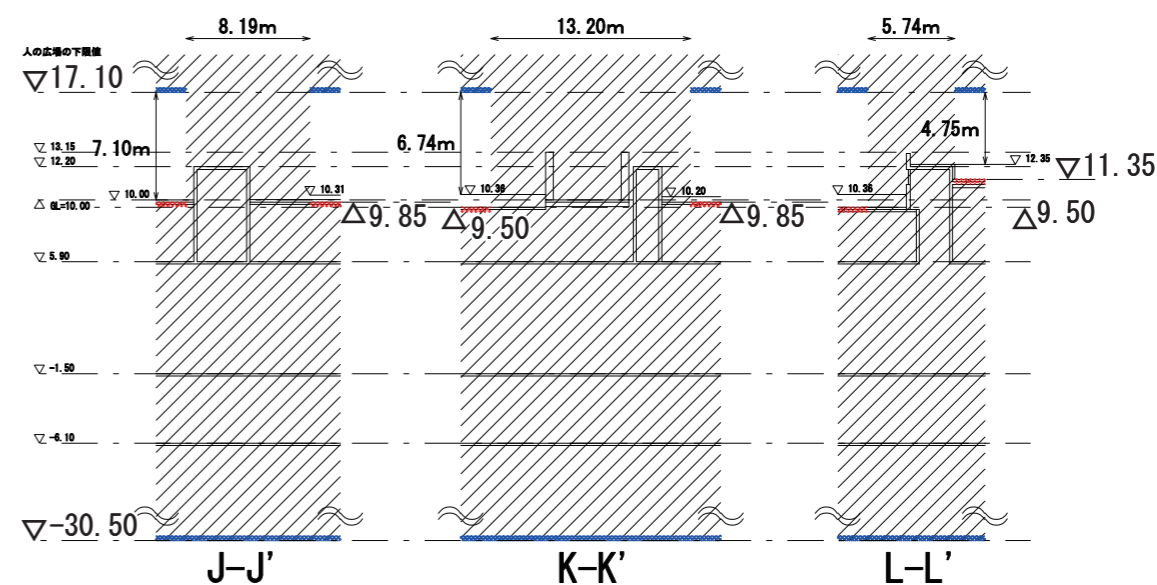
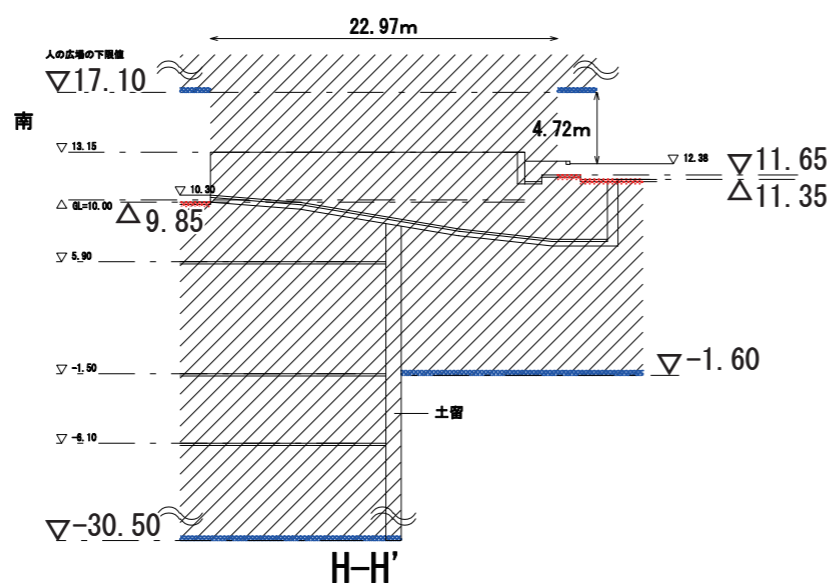
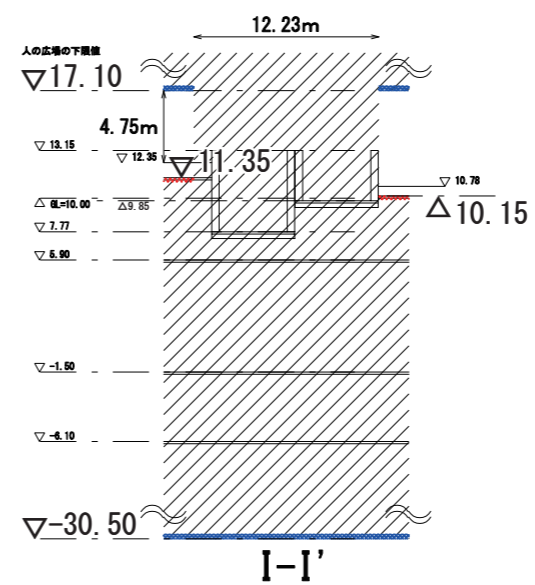
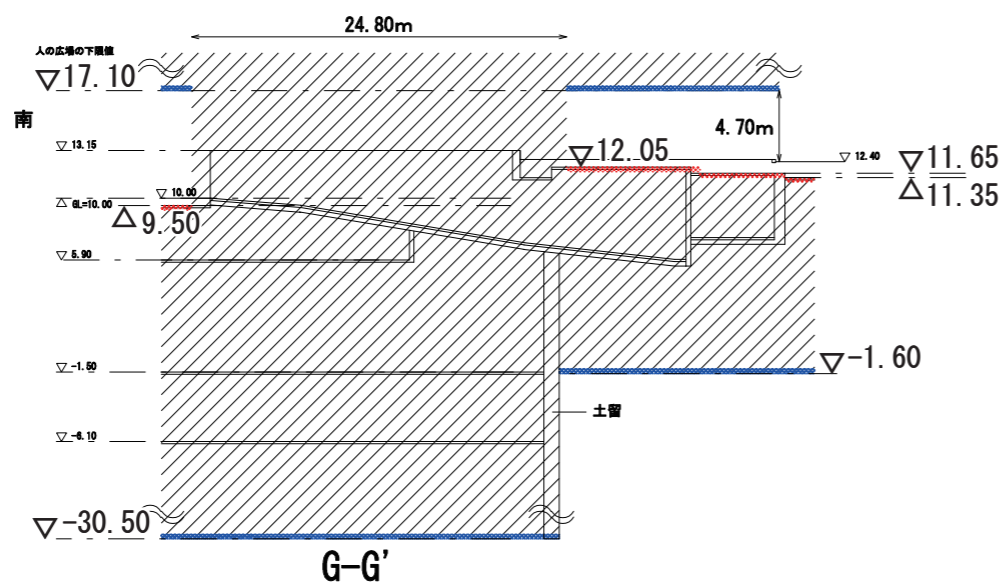

S=1:500

凡 例	
	建築物等の建築又は建設の限界（上限）
	建築物等の建築又は建設の限界（下限）
	重複利用区域内における建築等可能区域



S=1:500

凡 例	
	建築物等の建築又は建設の限界（上限）
	建築物等の建築又は建設の限界（下限）
	重複利用区域内における建築等可能区域